

户外系列

Outdoor series

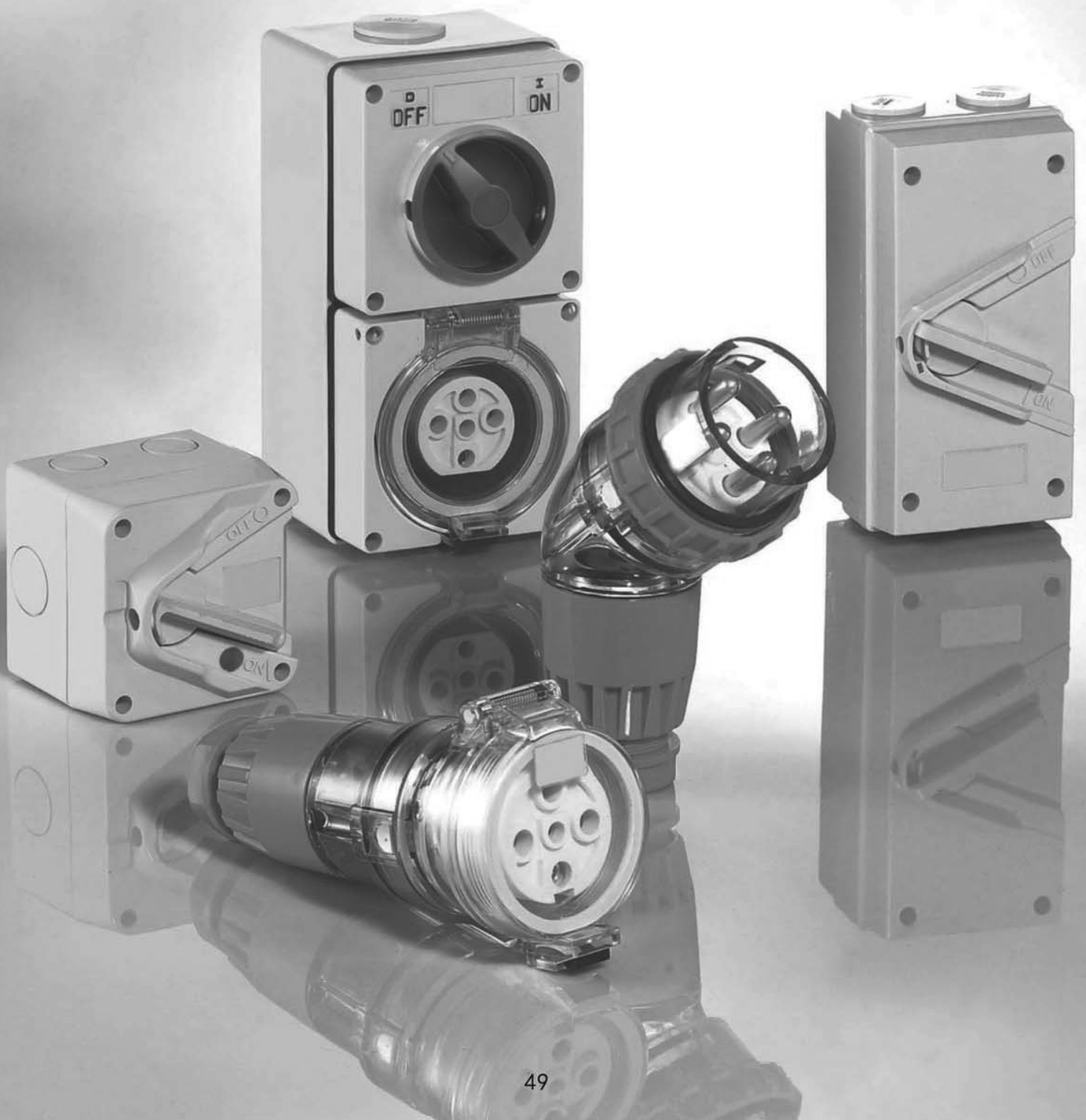

插头 Plug

产品外观
Photo



外形尺寸
Dimension

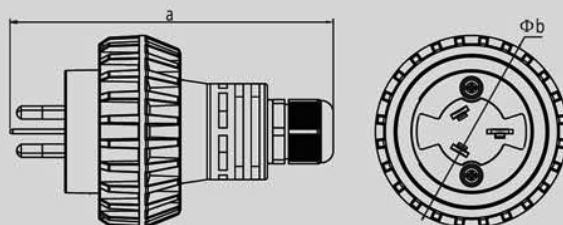

E56P310



3P 10A 250V

E56P315



3P 15A 250V

E56P313*



3P 13A 250V

参数

Parameter

电流(A) Current (A)	10	15	13
极数(P) Pole(P)	3	3	3
尺寸 Dimension(mm)	a	118	118
	b	71	71









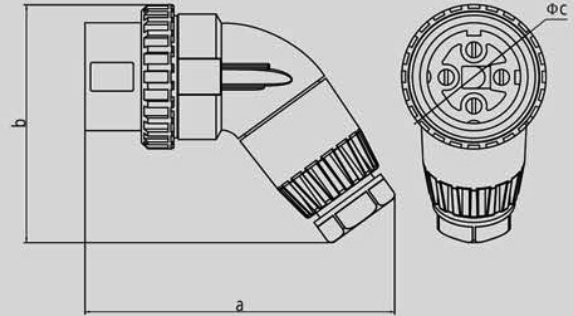



插头 Plug

产品外观
Photo



外形尺寸
Dimension



E56PA320	E56PA332	E56PA410	E56PA420	E56PA432
				
3P 20A 250V	3P 32A 250V	4P 10A 500V	4P 20A 500V	4P 32A 500V
E56PA440	E56PA450	E56PA510	E56PA520	E56PA532
				
4P 40A 500V	4P 50A 500V	5P 10A 500V	5P 20A 500V	5P 32A 500V
E56PA540	E56PA550			
				
5P 40A 500V	5P 50A 500V			

参数 Parameter	10		20			32			40		50	
	极数(P) Pole(P)		4	5	3	4	5	3	4	5	4	5
尺寸 Dimension(mm)	a	168	168	168	168	168	168	168	168	168	168	168
	b	130	130	130	130	130	130	130	130	130	130	130
	c	78	78	78	78	78	78	78	78	78	78	78

组合开关插座 Combination Switch Socket

产品外观
Photo



外形尺寸
Dimension

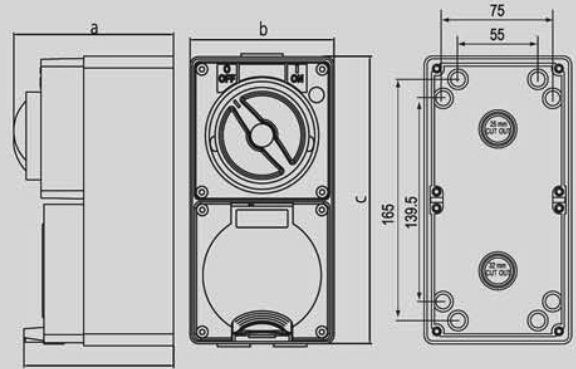

E56CV310	E56CV315	E56CV313*	E56CV316**	E56CV320	E56CV332
3P 10A 250V	3P 15A 250V	3P 13A 250V	3P 16A 250V	3P 20A 250V	3P 32A 250V
E56CV410	E56CV420	E56CV432	E56CV440	E56CV450	
4P 10A 500V	4P 20A 500V	4P 32A 500V	4P 40A 500V	4P 50A 500V	
E56CV510	E56CV520	E56CV532	E56CV540	E56CV550	
5P 10A 500V	5P 20A 500V	5P 32A 500V	5P 40A 500V	5P 50A 500V	

参数

Parameter

电流(A) Current (A)	10			13	15	20			32			40		50	
极数(P) Pole(P)	3	4	5	3	3	3	4	5	3	4	5	4	5	4	5
尺寸 Dimension(mm)	a	76	76	76	76	76	76	76	76	76	76	76	76	76	76
	b	101	101	101	101	101	101	101	101	101	101	101	101	101	101
	c	197	197	197	197	197	197	197	197	197	197	197	197	197	197

EWSC226



16A 250V IP56

EWSC226/2



16A 250V IP56