

NMC LIGHTNING PROTECTION

Conductor and Earthing Fittings

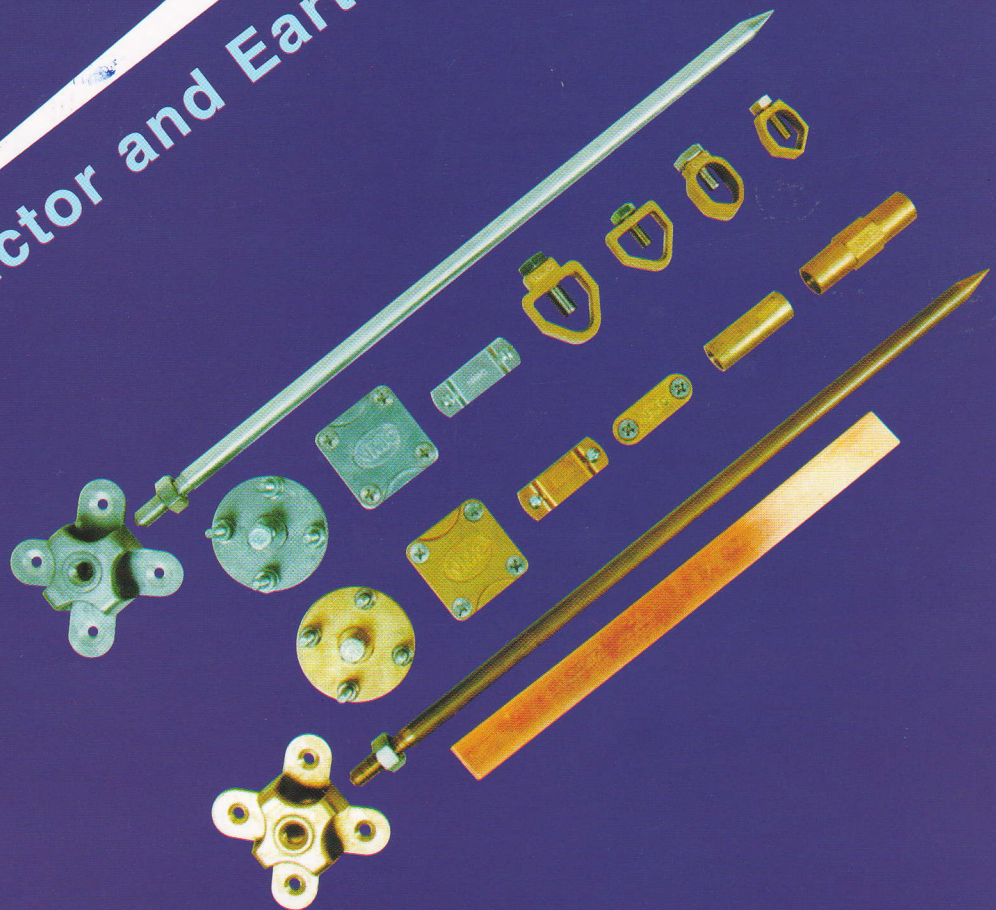

Air Terminal Fixings

Lightning Arrester

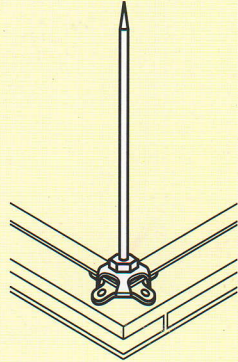
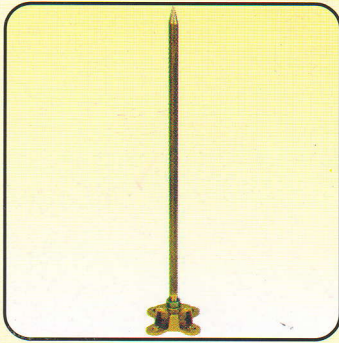

Brass or aluminium rod supplies in a wide range of lengths and diameters.

<u>Rod Diameter</u>	<u>Rod Length</u>
<u>mm</u>	<u>mm</u>
12	450
16	300

** Special length on request.

Conductor Fixings

Metal Bar Saddle

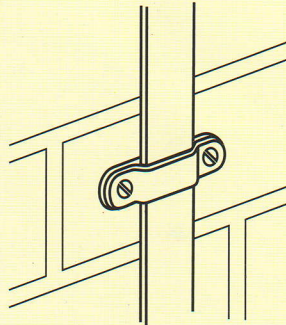

Bar Saddle are manufactured in brass, copper or aluminium for copper/ aluminium conductor.

Conductor Size : 25mm x 3mm

D/C Metal Tape Clip

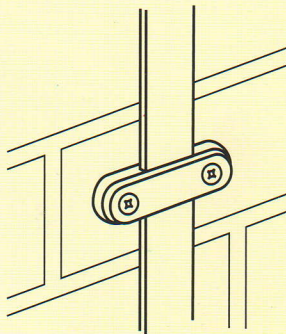

Direct contact clip manufactured from high quality Die-Cast brass or aluminium. Secures flat tape to structures by means of a screw and plug.

Conductor Size : 25mm x 3mm

Test and Connector Clamps

Square Tape Clamp

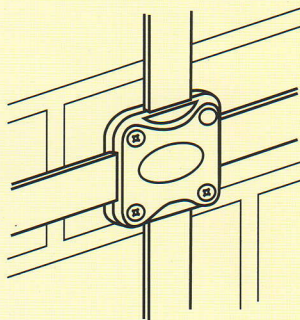
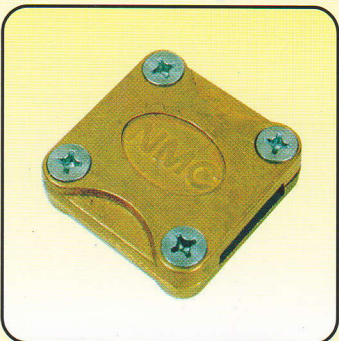

Manufactured in Die-Casting brass or aluminium. Suitable for 4-way connections in a continuous network of conductor tapes. The clamp has a countersunk hole in the base for securing in position, the clamp lid is secured by 4 countersunk stainless steel screws.

Conductor Size : 25mm x 3mm

Plate Type Test Clamp

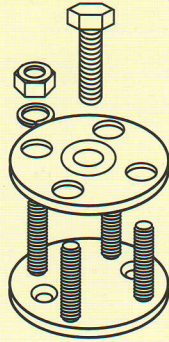

Manufactured in brass or aluminium. This clamp is used to form a disconnecting joint between the Down Conductor System and the Earthing System of a lightning conductor installation. This clamp can also be used as a 4-way clamp.

Bolts / Nuts are stainless steel

Conductor Size : 25mm x 3mm

Earthing

Earth Rod To Tape 'A' Clamp

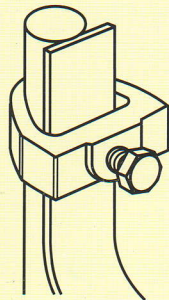

Die Casting in brass with a stainless steel bolt. Suitable for use with a combination of tape and rod sizes.

<u>Rod Diameter</u>	<u>Rod Length</u>
<u>mm</u> 16	<u>mm</u> 25

Earth Rod To Tape 'G' Clamp

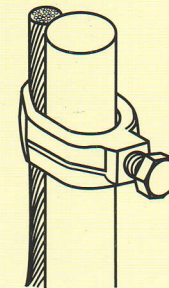

Die Casting in brass to suit various diameter earth rods and cables.

<u>Rod Diameter</u>	<u>Conductor Size</u>
<u>mm</u> 16	<u>mm</u> 16-70

Copper Rod Coupling/Socket

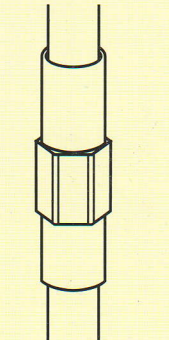

Manufactured from quality brass Die Casting, counter-bored to protect rod threads while allowing a full rod-to-rod contact for driving.

Rod Diameter : 16mm

Hard Drawn Copper Tape

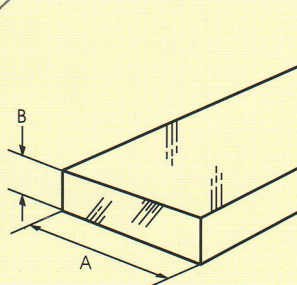
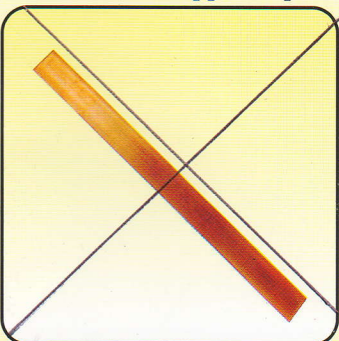

Manufactured from high conductivity copper tape BS 1432-1987 or Hard drawn aluminium tape.

<u>Conductor Size (A & B)</u>	<u>Material</u>	<u>Weight in coil</u>
25 x 3mm	Copper	50/70kg
25 x 3mm	Aluminium	11/20kg

NMC LIGHTNING PROTECTION CONDUCTOR AND EARTHING FITTINGS

KEY

- | | | | |
|---|-----------------------|---|-----------------------------|
| ① | Lightning Arrester | ⑥ | Earth Rod To Tape 'A' Clamp |
| ② | Metal Bar Saddle | ⑦ | Earth Rod To Tape 'G' Clamp |
| ③ | D/C Metal Tape Clip | ⑧ | Copper Rod Coupling /Socket |
| ④ | Square Tape Clamp | ⑨ | Hard Drawn Copper Tape |
| ⑤ | Plate Type Test Clamp | | |

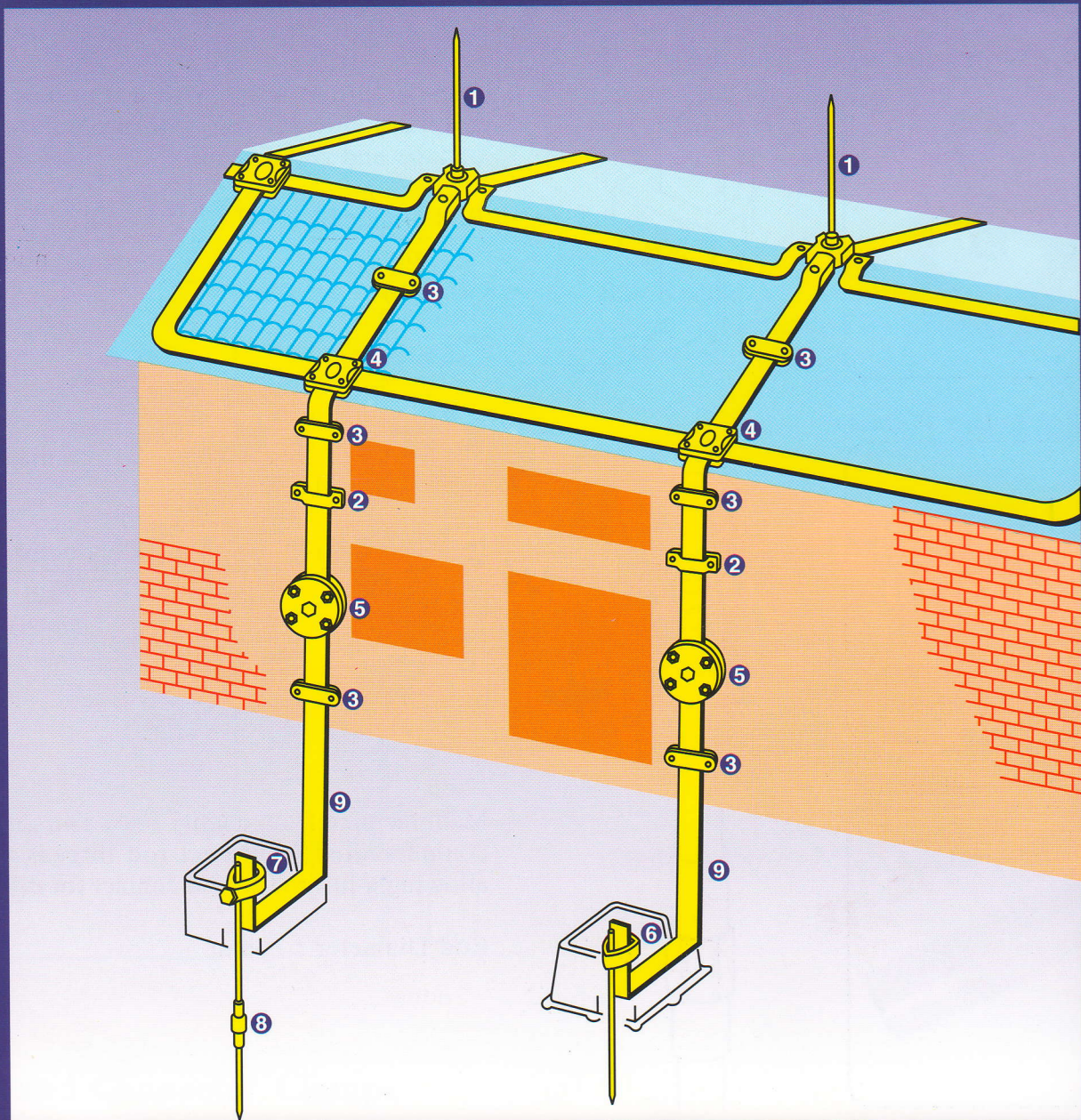

NMC

NONFERROUS METALCAST SDN. BHD. (109049-V)

LOT PT 3963, BATU KARANG, 31900 KAMPAR, PERAK, MALAYSIA.
P. O. BOX 5, 31907 KAMPAR.

TEL: 605-4669437, 4669446, 4664552 FAX: 605-4664030

HOME PAGE: <http://members.tripod.com/~nmcsb>

E.mail add: nmcsb@pd.jaring.my.